

A0852002 Havana Ribbon RGB-60 24V

Technical specifications:

LED system: 300x RGB-in-one LED (5050)
 View angle: 120°
 Light output Red: (1.036A) 600 Lumen/5mtr. (120 Lumen/mtr.)
 Light output Green: (0.958A) 1200 Lumen/5mtr. (240 Lumen/mtr.)
 Light output Blue: (0.823A) 750 Lumen/5mtr. (150 Lumen/mtr.)
 Light output White: (2.817A) 2250 Lumen/5mtr. (510 Lumen/mtr.)
 Power consumption: 5mtr max. 3A (67.6W)
 1mtr max. 0.6A (13.52W)
 Strip: IP20 (indoor use)
 Cutting length: 100mm (6 LED's) = 1.352W
 Working temperature: -20°C until +50° C
 Backside: Self adhesive 3M tape

The Havana Ribbon should not be used in hot places
 The best heat dissipation is to mount the Ribbon on an aluminum strip
 or Arctecta Alu-Pro Profile. Ensure a proper heat dissipation

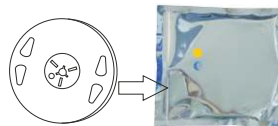

5 meter Havana Ribbon is packed on reel, in anti-static bag

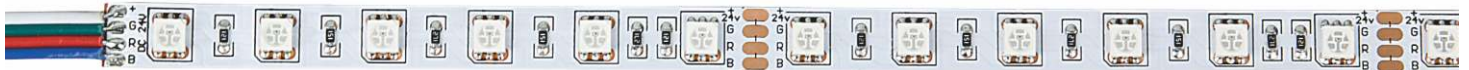
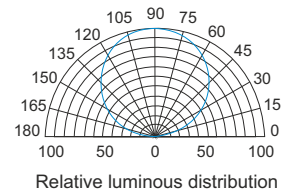

Advised 24V DC LED powersupplies:

- A9900360 DC 24V 30W (load max. 2m A0852002) (Dimensions: 145x47x30mm / 0.22 Kg)
- A9900361 DC 24V 60W (load max. 4m A0852002) (Dimensions: 181x62x35mm / 0.50 Kg)
- A9900362 DC 24V 96W (load max. 5m A0852002) (Dimensions: 200x71x35mm / 0.52 Kg)



Advised RGB DMX controllers:

- A9915060 Domotion DLC-4 black
- A9915061 Domotion DLC-4 white

A9915070 Domotion DLC-9

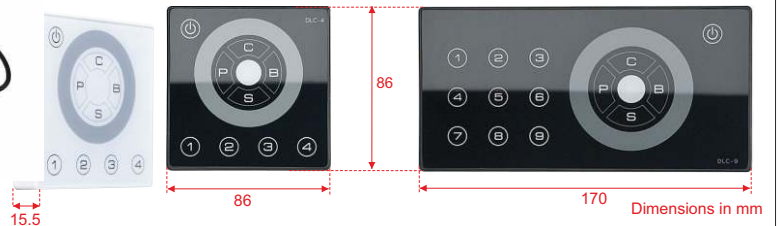

Advised DMX RGB PWM Dimmers:

A9915015 Domotion 3 ch. DMX Dimmer (Max. load: 1x 5mtr Havana Ribbon-60)



A9915011 3 ch. DMX Dimmer (Max. load: 2x 5mtr Havana Ribbon-60)

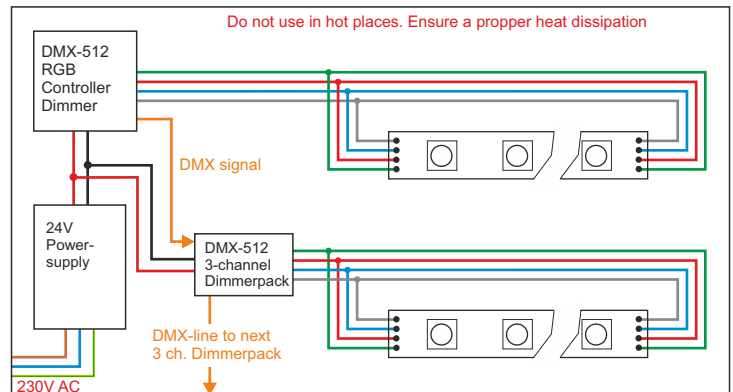
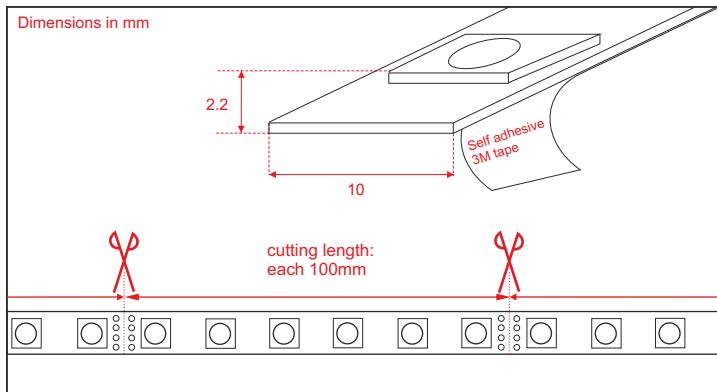

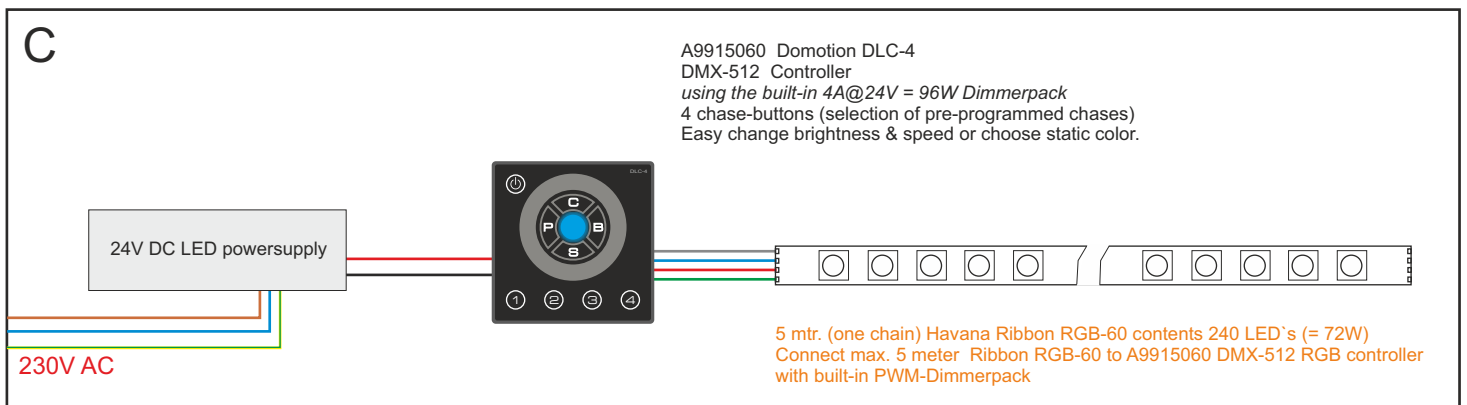
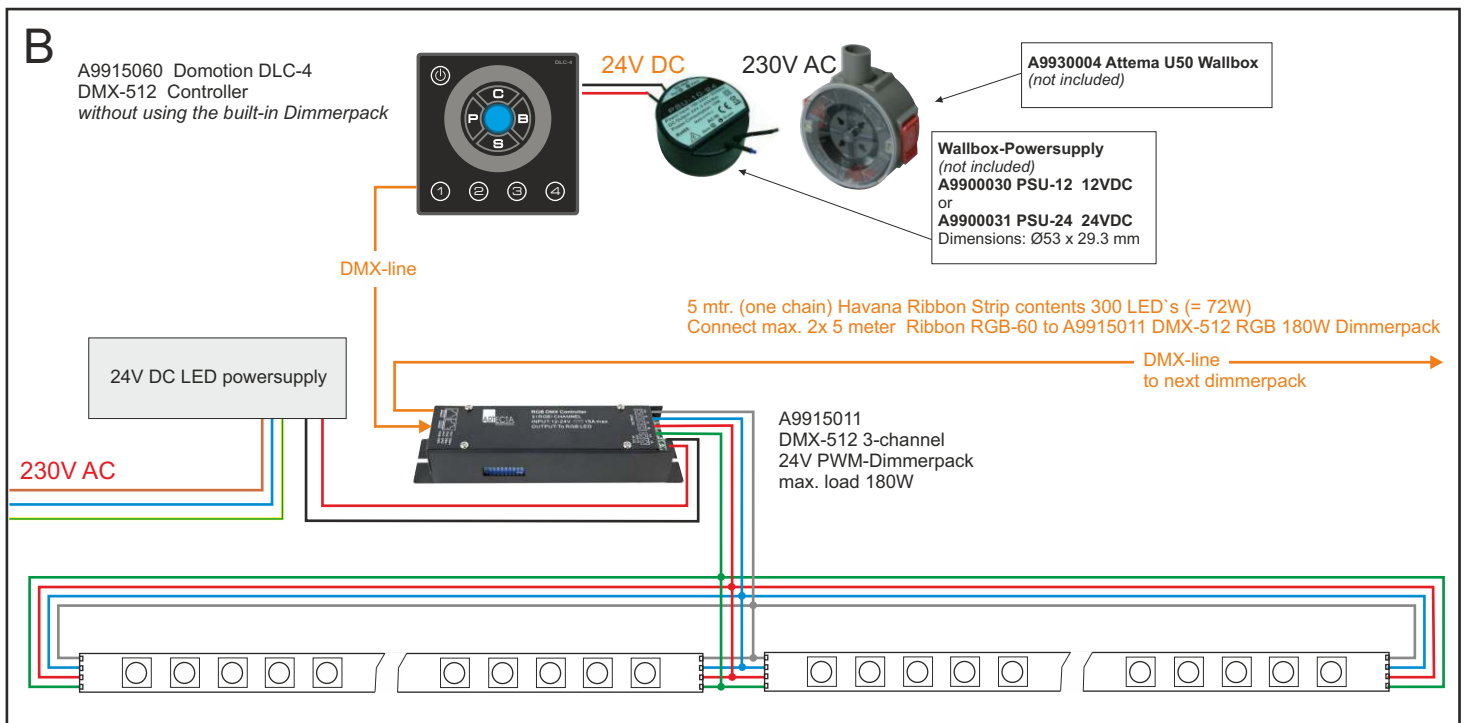
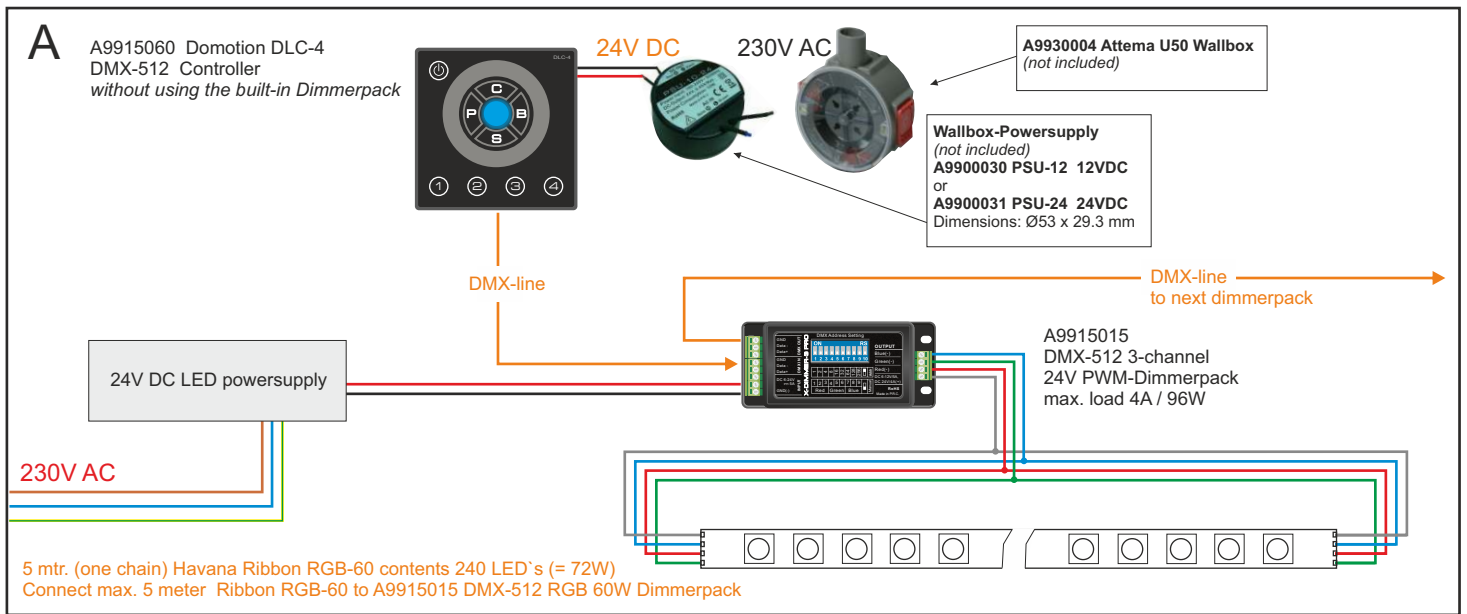

Notes:

UK
The thickness of the 24V DC cable depends on the total cable length and total power consumption of all connected fixtures. (See page 3)

NL
De diameter van de 24V DC-kabel is afhankelijk van de totale lengte van de kabel en het totale stroomverbruik van alle verbonden toestellen. (zie tabel op pagina 4)

D
Der Durchmesser des 24V DC-Kabels hängt von der Gesamtlänge des Kabels und der gesamten Leistungsaufnahme aller angeschlossenen Geräte ab. (Siehe Tabelle auf Seite 5)

FR
Le diamètre du câble d'alimentation 24V DC dépend de la longueur totale du câble et la consommation électrique totale de tous les périphériques connectés. (voir page 6)

ES
La sección del cable de 24V DC depende de la longitud total del cable y el consumo de energía total de todas las luminarias (véase la página 7)

IT
Il diametro del cavo 24V DC dipende dalla lunghezza totale del cavo e il consumo di energia totale di tutti apparecchi collegati.

Recommended cable conductor surface (mm²) with cable lengths of 1-50 meters. for parallel connected 24 volt LED fixtures.

Note; This table is an obligation and not a binding opinion. If necessary, make a electrical resistance calculation ($Pouillet A \times R = p \times l$)

24 Volt	Cable inner conductor 1.5mm ²					Cable inner conductor 2.5mm ²					Cable inner conductor 4mm ²					
	Watt	24	48	72	96	120	144	168	192	216	240	264	288	312	336	360
Kabel- lengte (m)	Ampere	1	2	3	4	5	6	7	8	9	10	11	12	13	14	15
1																
2																
3																
4																
5																
6																
7																
8																
9																
10																
11																
12																
13																
14																
15																
16																
17																
18																
19																
20																
21																
22																
23																
24																
25																
26																
27																
28																
29																
30																
31																
32																
33																
34																
35																
36																
37																
38																
39																
40																
41																
42																
43																
44																
45																
46																
47																
48																
49																
50																

- As much as possible shortest path for the 12V cables
- Branching cables without interrupting the main cable
- Transformer must be placed in centre of the connected fixtures
- Polarity: positive (+) = red or brown, minus (-) = black or blue
- Transformer-capacity 25% greater than the sum of conected fixtures

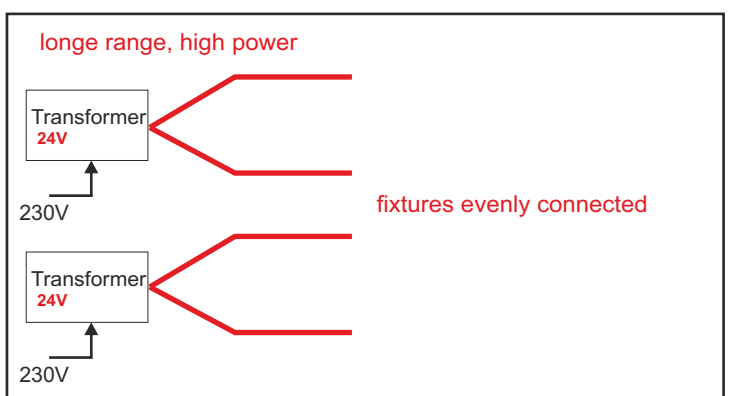
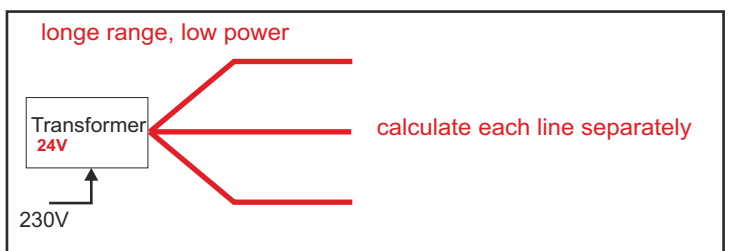
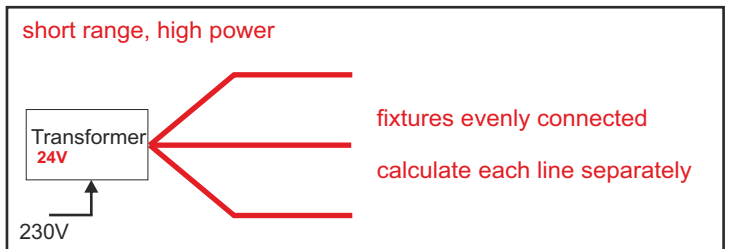
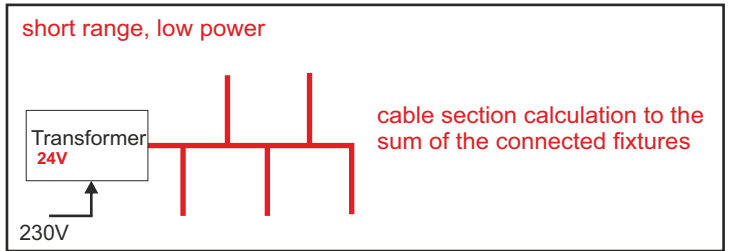

Geadviseerd kabelgeleider-oppervlak (mm²) bij kabellengtes van 1-50 mtr. voor 24 Volt parallel aangesloten LED armaturen.

Note; Deze tabel is een vrijblijvend en geen dwingend advies. Maak indien nodig een berekening van elektrische weerstand en geleidbaarheid met de wet van Pouillet ($A \times R = p \times l$)

24 Volt	Kabelgeleider 1.5mm ²					Kabelgeleider 2.5mm ²					Kabelgeleider 4mm ²				
	Watt	24	48	72	96	120	144	168	192	216	240	264	288	312	336
Kabel-lengte (m) \ Ampere	1	2	3	4	5	6	7	8	9	10	11	12	13	14	15
1															
2															
3															
4															
5															
6															
7															
8															
9															
10															
11															
12															
13															
14															
15															
16															
17															
18															
19															
20															
21															
22															
23															
24															
25															
26															
27															
28															
29															
30															
31															
32															
33															
34															
35															
36															
37															
38															
39															
40															
41															
42															
43															
44															
45															
46															
47															
48															
49															
50															

Zoveel mogelijk kortste weg voor de 24V kabels

Kabels aftakken zonder de hoofdkabel te onderbreken

Trafo mogelijk in het midden plaatsen

Polariteit: plus(+) = rood of bruin, min(-) = zwart of blauw

Trafo-capaciteit 25% hoger kiezen dan de som der belastingen

korte afstanden, laag vermogen

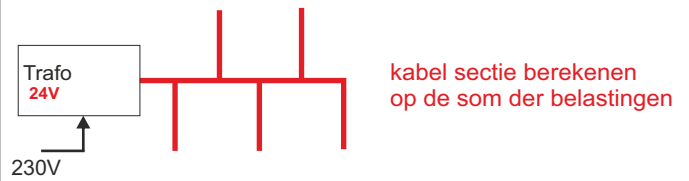

korte afstanden, hoog vermogen



lange afstanden, laag vermogen



lange afstanden, hoog vermogen



Empfohlener Querschnitt vom Kabelinnenleiter in mm² bei Kabellängen von 1-50 Meter für parallel geschaltete 24-Volt-LED-Leuchten.

Bitte beachten: Diese Tabelle ist eine unverbindliche Beratung. Falls erforderlich, eine Berechnung vom elektrischen Widerstand und Leitfähigkeit mit der Formel von Pouillet machen

24 Volt		Kabelinnenleiter 1.5mm ²					Kabelinnenleiter 2.5mm ²					Kabelinnenleiter 4mm ²				
		Leistung (Watt)														
Leistung (Watt)		24	48	72	96	120	144	168	192	216	240	264	288	312	336	360
Kabel- länge (m)	Ampere	1	2	3	4	5	6	7	8	9	10	11	12	13	14	15
	1															
2																
3																
4																
5																
6																
7																
8																
9																
10																
11																
12																
13																
14																
15																
16																
17																
18																
19																
20																
21																
22																
23																
24																
25																
26																
27																
28																
29																
30																
31																
32																
33																
34																
35																
36																
37																
38																
39																
40																
41																
42																
43																
44																
45																
46																
47																
48																
49																
50																

- So viel wie möglich dem kürzesten Weg für die 24V-Leitungen
- Kabel abzweigen ohne Unterbrechung der Hauptleitung
- Trafo wenn möglich in der Mitte montieren
- Polarität: positiv(+) = rot oder braun, minus(-) = schwarz oder blau
- Trafo-Kapazität immer 25% größer wählen als die Summe der Last

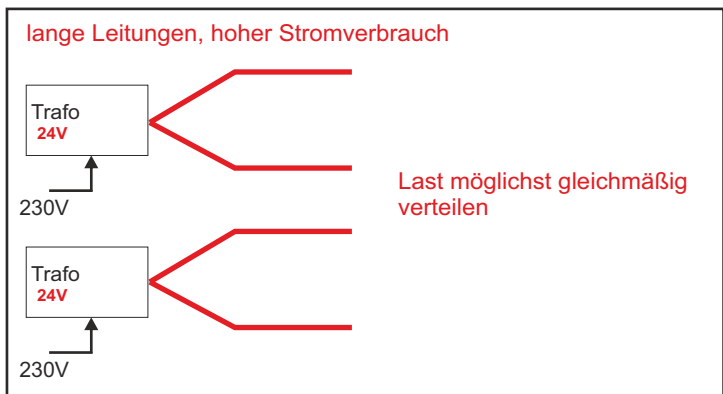
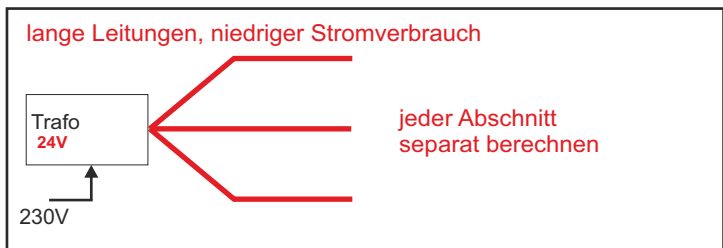
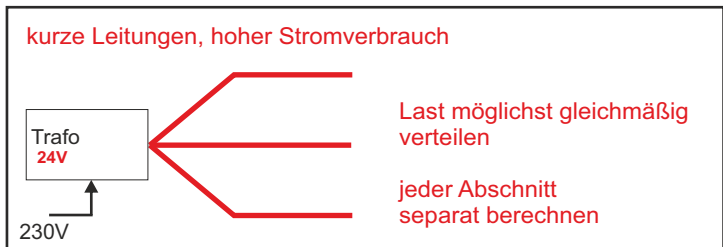
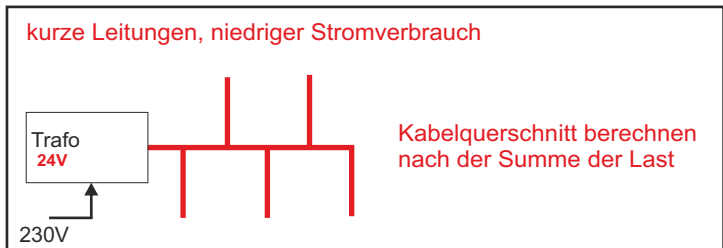

Surface recommandée conducteur de câble (mm²) 1-50 m longueurs de câble. connectés en parallèle pour 24 volts luminaires à LED.

Remarque, Ce tableau est un des conseils informels et non contraignants. Si nécessaire, un calcul de résistance électrique et la conductivité avec la loi de Pouillet ($A \times R = p \times l$)

24 Volts		Conducteur de câble 1.5mm ²					Conducteur de câble 2.5mm ²					Conducteur de câble 4mm ²				
		Puissance (Watt)					Puissance (Watt)					Puissance (Watt)				
Kabel- länge (m)	Ampere	24	48	72	96	120	144	168	192	216	240	264	288	312	336	360
		1														
	2															
	3															
	4															
	5															
	6															
	7															
	8															
	9															
	10															
	11															
	12															
	13															
	14															
	15															
	16															
	17															
	18															
	19															
	20															
	21															
	22															
	23															
	24															
	25															
	26															
	27															
	28															
	29															
	30															
	31															
	32															
	33															
	34															
	35															
	36															
	37															
	38															
	39															
	40															
	41															
	42															
	43															
	44															
	45															
	46															
	47															
	48															
	49															
	50															

Choisir le chemin le plus court pour les câbles 24V

Éclaircie câbles sans interrompre le câble principal

Transformateur peut être centrée

Polarité: positive (+) = rouge ou brun, moins (-) = noir ou bleu

Transformateur-capacité de 25% de plus que de choisir la charge

LED-lampes Parallèlement interrupteur

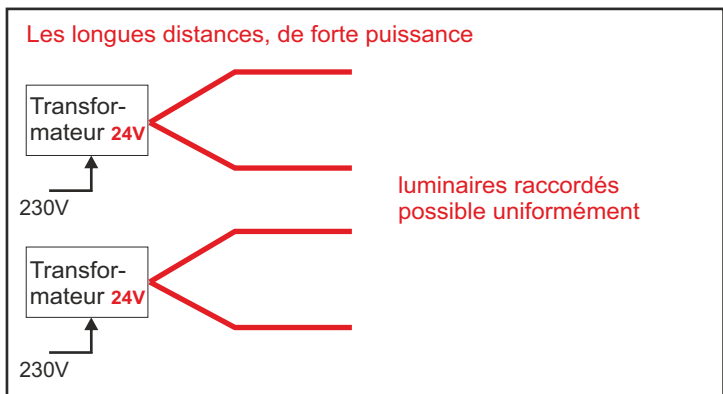
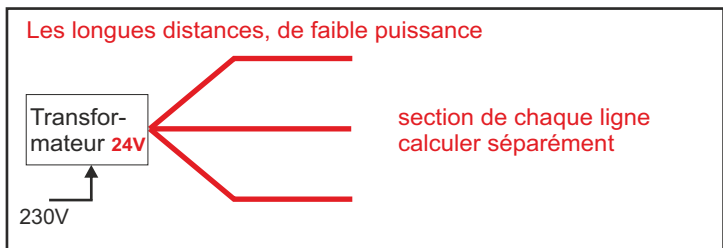
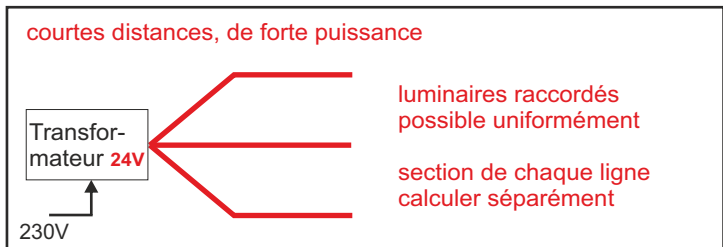
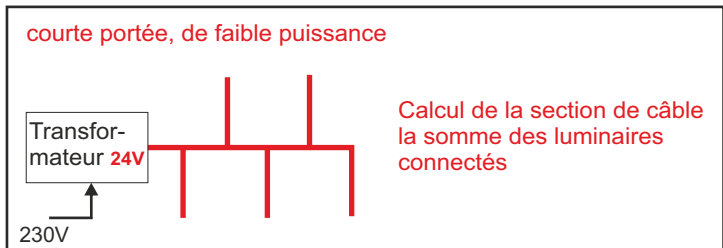

Sección de cable recomendada en mm² con longitudes de cable 1-50 metros. para conectar en paralelo de 24 voltios LED fixtures.

Note; Este cuadro es un consejo informal y no vinculante. Si es necesario, un cálculo de resistencia eléctrica y la conductividad con la ley de Pouillet ($A \times R = p \times l$)

24 Voltios	Sección de cable 1.5mm ²					Sección de cable 2.5mm ²					Sección de cable 4mm ²					
	Watt	24	48	72	96	120	144	168	192	216	240	264	288	312	336	360
Kabel- lengte (m)	Ampere	1	2	3	4	5	6	7	8	9	10	11	12	13	14	15
1																
2																
3																
4																
5																
6																
7																
8																
9																
10																
11																
12																
13																
14																
15																
16																
17																
18																
19																
20																
21																
22																
23																
24																
25																
26																
27																
28																
29																
30																
31																
32																
33																
34																
35																
36																
37																
38																
39																
40																
41																
42																
43																
44																
45																
46																
47																
48																
49																
50																

Intente utilizar la mínima distancia de cable en líneas de 12V.

Intente utilizar una línea principal sin cortarlo y sacar de el derivaciones individuales

Si es posible coloque la fuente de alimentación en el centro de la línea [principal de distribución]

Polaridad: positivo (+) = rojo o marrón, negativo (-) = negro o azul

La fuente de alimentación debe ser 25% mayor que la suma de las luminarias a conectar

distancias cortas, de baja potencia

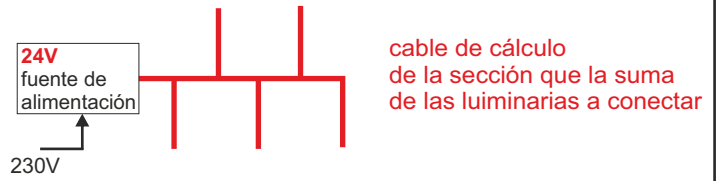

distancias cortas, de alta potencia

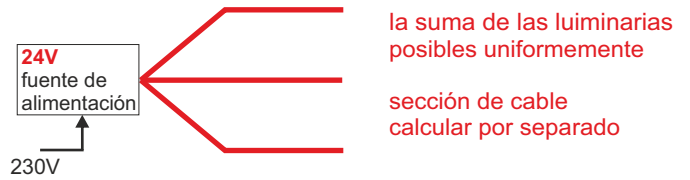

distancias largas, de baja potencia

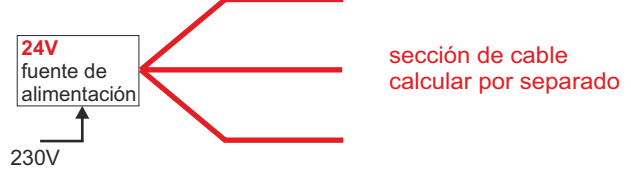

distancias largas, de alta potencia

